

GLOBO

LIGHTING

www.globo-lighting.com

48027-30SH
48027-40SH

48027-30SH	LED 30W SMD 36-46V RGB LED 13.8W 220-240~ 50/60Hz
48027-40SH	LED 40W SMD 36-46V RGB LED 18.4W 220-240~ 50/60Hz
Frequency Bandwith	Maximal radiation transmitting power
2412-2472 MHz	10 dBm

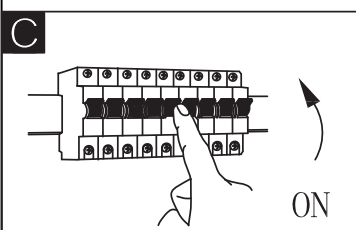
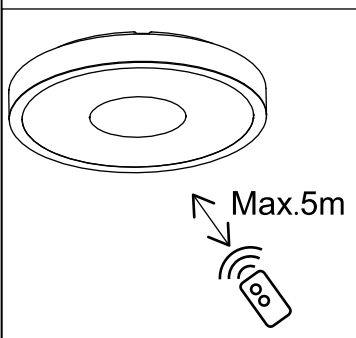
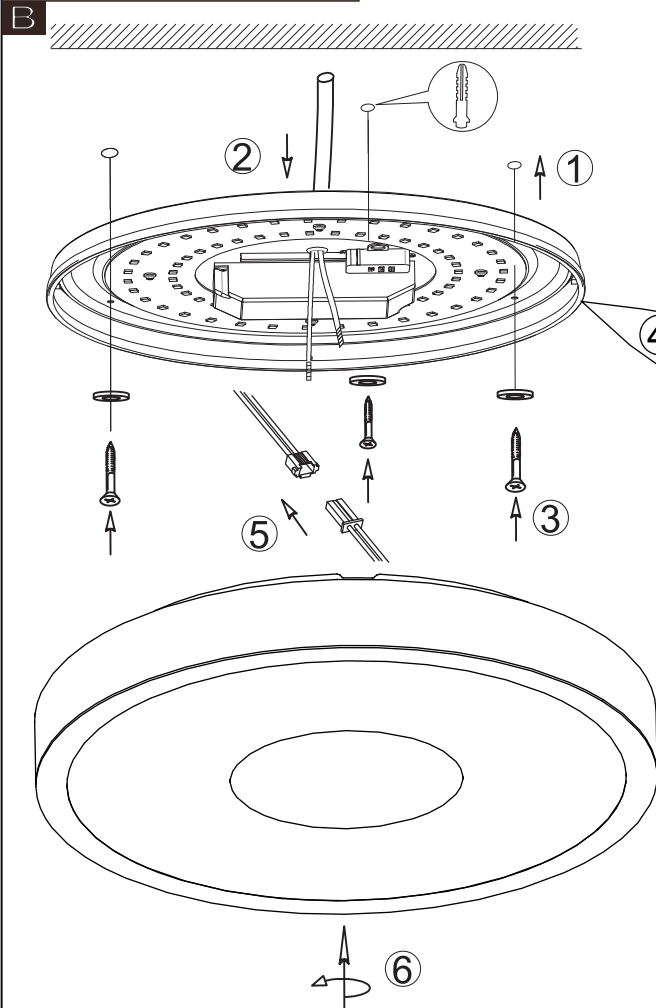
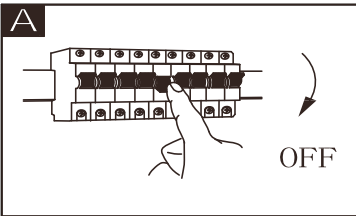
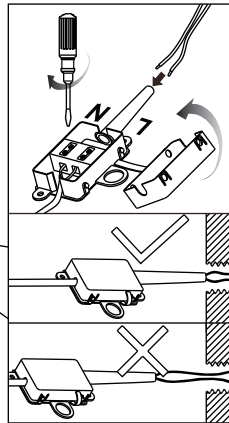

GLOBO Handels GmbH
Gewerbestr. 3
A-9184 Sankt Peter Austria

- incl.
- colour change
- dimmable
- 2700K-6500K
- night light
- memory function
- sparkle decor
- IP44

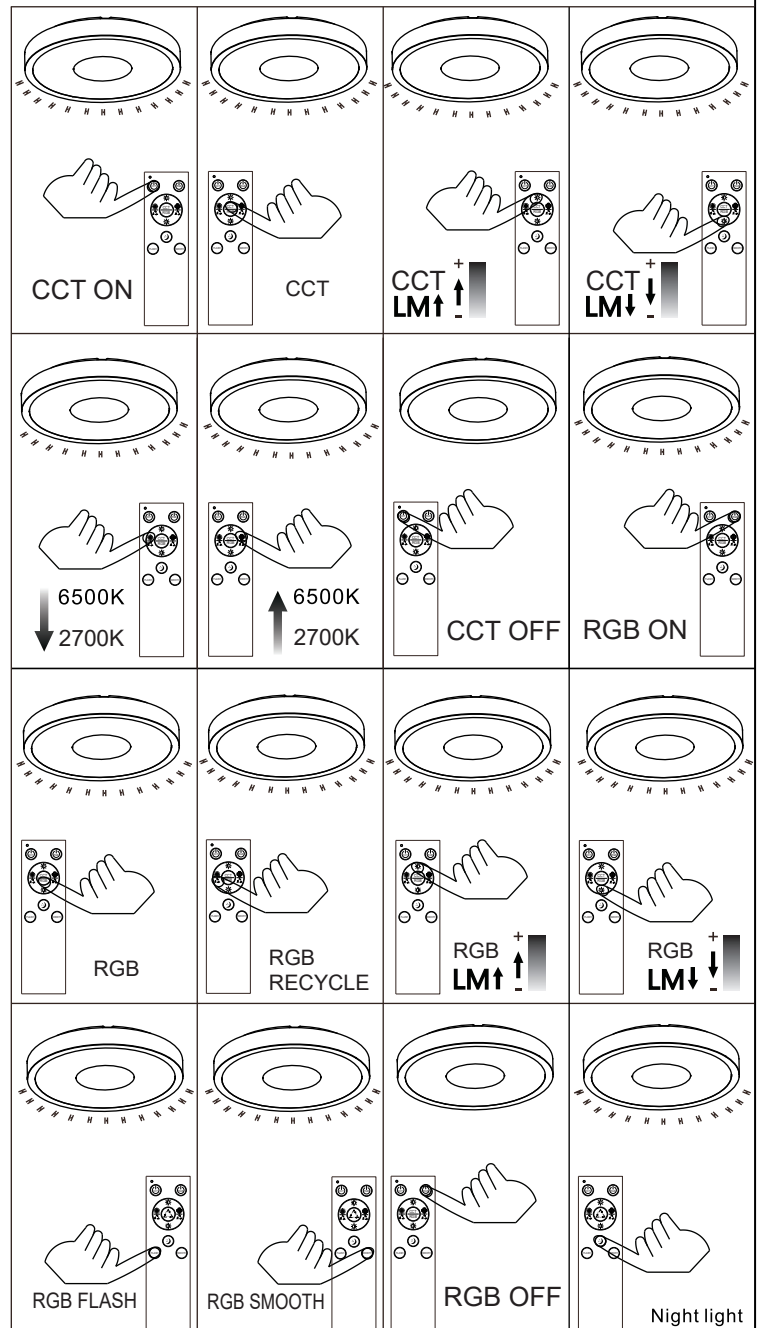

**Download
Tuya App:**



**Get latest
manual:**



**Functional
Video:**



Tuya App - Pairing Process

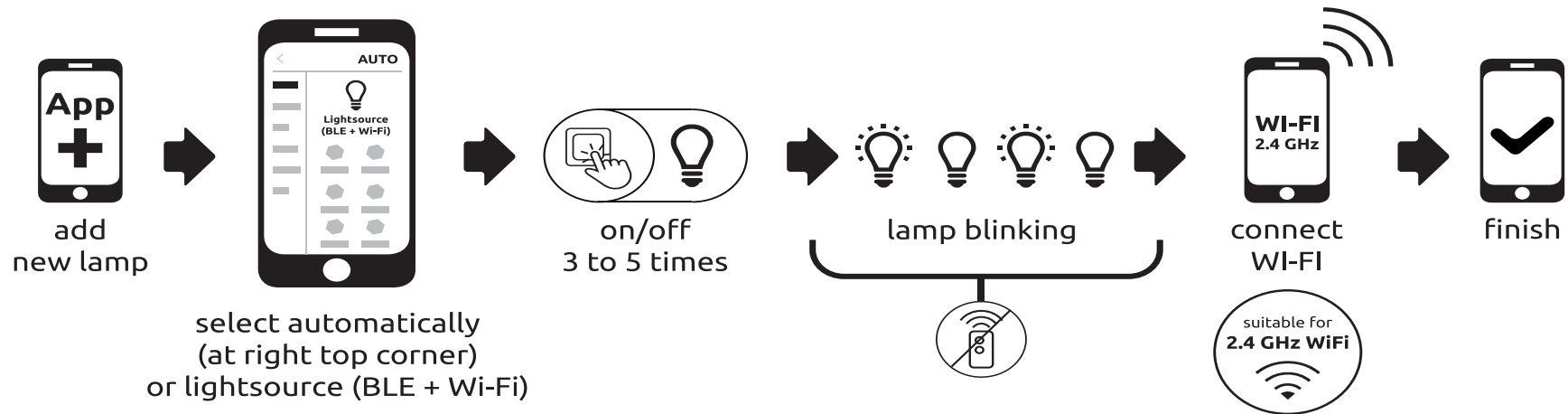

08:00 to 16:00
(Monday to Friday)

+43 (0)4253 320 50 083
(Please consider, your telephone operator's usual charges for calls to Austria will apply.)

Lichtquelle:

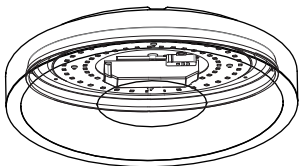

DEU:

Lichtquelle:

Die Lichtquelle ist nichttauschbar, weil sie konstruktionsbedingtfest mit dem umgebenden Produkt verbunden ist.

Dieses Produkt enthält eine Lichtquelle der Energieeffizienzklasse <E>.

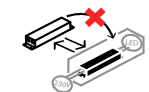

Die LED - Lichtquelle ist nicht austauschbar.

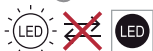

Das Betriebsgerät ist nicht austauschbar.

GBR:

Light source:

The light source is not interchangeable because it is determined by the surrounding product design. This product contains a light source of energy efficiency class <E>.

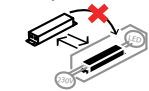

The LED - light source cannot be replaced.

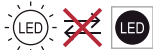

The control gear cannot be replaced.

BIH:

Izvor svjetla :

Izvor svjetla nije zamjenjiv , jer je konstrukcijski pričvršćen na proizvod . Ovaj proizvod sadržava izvor svjetlosti klase energetske učinkovitosti <E>.

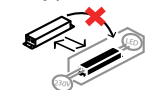

LED – izvor svjetla nije moguće zamjeniti

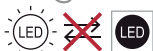

Pogonski uređaj se ne može zamjeniti .

BG:

Източник на светлина:

Източникът на светлина не може да се подменя, тъй като поради конструкцията си е трайно фиксиран към заобикалящия го продукт.

Този продукт включва светлинен източник с клас на енергийна ефективност <E>.

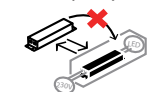

LED източникът на светлина не може да се подменя.



Устройството за управление не може да се подменя.

CZ:

Zdroj světla:

Světelný zdroj není možné vyměnit, protože je díky své konstrukci pevně spojený s produktem. Tento výrobek obsahuje světelný zdroj s třídou energetické účinnosti <E>.

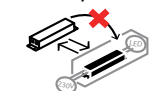

Světelný zdroj není vyměnitelný.



Předřadník není vyměnitelný.

DK:

Lyskilde:

Lyskilden kan ikke udskiftes, fordi den er fastforbundet med det omgivende produkt. Dette produkt indeholder en lyskilde i energieffektivitetsklasse < E >.



LED- lyskilden kan ikke udskiftes.

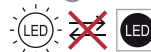

Driftsenheden kan ikke udskiftes.

ET:

Valgusallikas:

Valgusallikas ei ole välja vahetatav, sest ta on tootega ehituslikult kindlalt seotud. Toode sisaldab energiatõhususe klassi <E> valgusallikat.

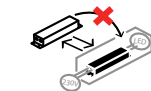

LED - valgusallikat ei saa asendada.

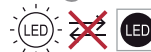

Juhtseadet ei saa asendada.

FI:

Valonlähde:

Valonlähdettä ei voi vaihtaa uuteen, sillä se on rakenteellisesti yhdistetty ympäröivään tuotteeseen. Tämä tuote sisältää valonlähteen, jonka energiatehokkuusluokka on <E>.

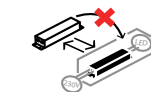

LED-valonlähdettä ei voi vaihtaa uuteen.

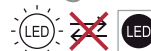

Liitäntälaitetta ei voi vaihtaa uuteen.

FR:

Source lumineuse:

La source lumineuse n'est pas remplaçable car elle est, de par la construction du produit, liée de façon permanente à celui-ci.

Ce produit contient une source lumineuse de classe d'efficacité énergétique <E>.

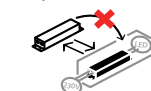

La source lumineuse LED n'est pas remplaçable.

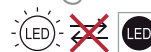

L'unité de contrôle n'est pas remplaçable.

GR:

Φωτεινή πηγή:

Η φωτεινή πηγή δεν μπορεί να αντικατασταθεί, επειδή είναι για κατασκευαστικούς λόγους σταθερά συνδεδεμένη με το προϊόν που την περιβάλλει.

Το προϊόν αυτό περιέχει φωτεινή πηγή της τάξης ενεργειακής απόδοσης <E>.

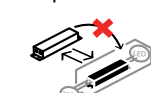

Η φωτεινή πηγή LED δεν αντικαθίσταται.



Η λειτουργική συσκευή δεν αντικαθίσταται.

HU:**Fényforrás:**

A fényforrás nem cserélhető, mert felépítése miatt szilárdan csatlakozik a termékhez

Ez a termék egy <E> energiahatékonysági osztályú fényforrást tartalmaz.

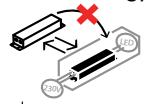

A fényforrás nem cserélhető



Az előtét nem cserélhető.

Ísländisch/IS:**Ljósgrjafi:**

Ljósgrjafiinn er ekki útskiptanlegur vegna þess að hann er háður umliggjandi hönnun vörunnar.

Varan inniheldur ljósgrjafa í orkuflokki <E>.

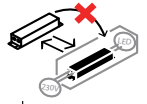

Ekki er hægt að skipta um LED-ljósgrjafann.



Ekki er hægt að skipta um stjórnbúnaðinn.

IT:**Sorgente luminosa:**

La sorgente luminosa non è intercambiabile perché è saldamente collegata al prodotto per via del suo design.

Questo prodotto contiene una sorgente luminosa di classe di efficienza energetica <E>.

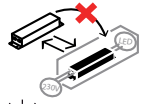

La sorgente luminosa a LED non può essere sostituita.



La centralina non può essere sostituita

LV:**Gaismas avots:**

Gaismas avotu nevar nomaiņīt, jo tas konstrukcijā ir cieši savienots ar izstrādājuma apkārtējo daļu.

Šis ražojums satur gaismas avotu, kura energoefektivitātes klase ir <E>.



LED apgaismes līdzekli nevar nomaiņīt.

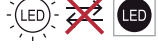

Vadības ierīci nevar nomaiņīt.

LT:**Šviesos šaltinis:**

Šis šviesos šaltinis yra nekeičiamas, nes jis prijungtas prie gaminio pagal jo konstrukciją.

Šiame gaminyje yra šviesos šaltinis, kurio energijos vartojimo efektyvumo klasė <E>.



LED šviesos šaltinis yra nekeičiamas.

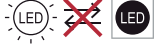

Valdymo įtaisas yra nekeičiamas.

NL:**Lichtbron:**

De lichtbron kan niet worden vervangen, omdat deze vanwege de constructie vast met het product eromheen verbonden is.

Dit product bevat een lichtbron van energie-efficiëntieklasse <E>.

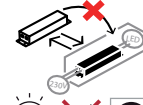

De LED-lichtbron kan niet worden vervangen.



Het apparaat kan niet worden vervangen.

Norwegisch/Norwegian / NO:**Lyskilde:**

Lyskilden kan ikke byttes fordi den sitter fast i produktet.

Dette produktet inneholder en lyskilde i energiklasse <E>.

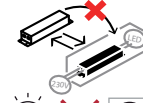

LED-lyspæren kan ikke byttes.



Driverenheten kan ikke byttes.

PL:**Źródło światła:**

Źródła światła nie można wymienić, ponieważ jest zintegrowane z produktem ze względu na swoją konstrukcję.

Ten produkt zawiera źródło światła o klasie efektywności energetycznej <E>.

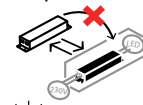

LED - źródło światła nie może być wymienione.



Nie można wymienić przekładni sterującej.

PT:**Fonte de Luz:**

A fonte de luz não é substituível porque devido às suas características construtivas está fixada de forma permanente ao produto circundante.

Este produto contém uma fonte de luz da classe de eficiência energética <E>.

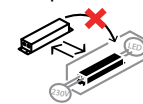

Lâmpada não substituível.



Equipamento de controlo não substituível.

RO:**Sursa de lumina:**

Sursa de lumina nu este inlocuibilă ea fiind parte constructivă a produsului

Acest produs conține o sursă de lumină cu clasa de eficiență energetică <E>.

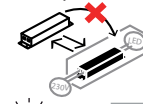

Sursa de lumina nu poate fi înlocuită



Driverul nu poate fi înlocuit

RUS:**Источник света:**

Источник света не является взаимозаменяемым, поскольку это определяется конструкцией смежного продукта.

Данный продукт содержит источник света класса энергоэффективности <E>.

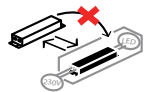

Светодиодный источник света не подлежит замене.



Устройство управления не подлежит замене.

SRB:**Izvor svetlosti:**

Izvor svetlosti nije zamenljiv, jer je zbog svog dizajna čvrsto povezan sa proizvodom koji ga opkružuje.

Ovaj proizvod sadrži izvor svetlosti klase energetske efikasnosti <E>.

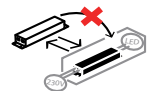

LED izvor svetlosti nije zamenljiv.

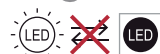

Upravljački uređaj nije zamenljiv.

SK:**Zdroj svetla:**

Svetelný zdroj nie je možné vymeniť, pretože je vďaka svojej konštrukcii pevne spojený s produktom .

Tento výrobok obsahuje svetelný zdroj triedy energetickej účinnosti <E>.

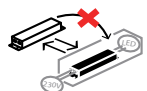

Svetelný zdroj nie je vymeniteľný.



Predradnik nie je vymeniteľný.

SI:**Izvor svetlobe:**

Vir svetlobe ni zamenljiv, ker je določen z zasnovo izdelka v okolici.

Ta izdelek vsebuje svetlobni vir razreda energijske učinkovitosti <E>.

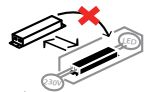

Svetlobni vir ni mogoče zamenjati.

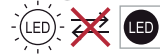

Krmilnik ni mogoče zamenjati.

ES:**Fuente de luz:**

La fuente de luz no es sustituible porque está fija en el producto desde la construcción.

Este producto contiene una fuente luminosa de la clase de eficiencia energética <E>.

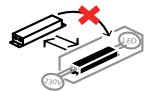

Bombilla no reemplazable.

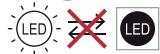

Dispositivo de control no reemplazable.

SE:**Ljuskälla:**

Ljuskällan är inte utbytbar, eftersom den på grund av konstruktionen är fast integrerad i den omgivande produkten.

Denna produkt innehåller en ljuskälla med energieffektivitetsklass <E>.

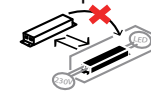

LED-ljuskällan kan inte bytas ut.

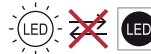

Driftdonet kan inte bytas ut.

TR:**Işık kaynağı:**

Konstrüksiyon gereği çevreyeyen ürün ile sabit bir şekilde bağlı olduğu için ışık kaynağı değiştirilemez. Bu ürün, <E> enerji sınıfından bir ışık kaynağına sahiptir.

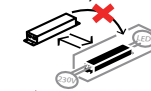

LED ışık kaynağı değiştirilemez.

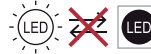

İşletme cihazı değiştirilemez.

UK:**Джерело світла:**

Джерело світла не можна обміняти, оскільки воно міцно пов'язане з навколишнім виробом завдяки своїй конструкції.

Цей виріб містить джерело світла класу енергоефективності <E>.

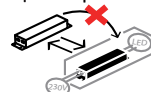

джерело світлодіодного світла не можна замінювати.

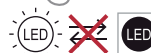

пристрій керування не можна замінювати.